

# ALL-IN-ONE ESS SYSTEM

Solar Energy Storage System for Home

---

## User Manual



This brochure is presented by our company. Before installing the energy storage system, please read this manual first, and carefully follow the instructions during the installation process.  
In case of any doubt, please contact us immediately for advice and technical support.

## Contents

### Instructions

1.Instructions description.....	03
2.Before connection.....	03
3.During usage.....	03
4.Important safety information.....	04
5.Normal safety instructions.....	04

### Introduce of energy storage ESS system

1.System introduction.....	05
2.System features.....	05
3.Maintenance.....	05

### Interface introduction of energy storage ESS system

1.System icon.....	06
2.Interface Introduction.....	07
3.Display interface introduction.....	08

### Function introduction of energy storage ESS system

1.Display function introduction.....	09
1.1Lithium battery pack.....	10
1.2Solar inverter.....	11
2.Introduction to working mode.....	12
2.1Introduction to the work interface(Mains and PV input are normal ).....	12
2.2Introduction to working mode.....	14
2.3Introduction to three working modes.....	14
3.Function setting operation.....	14
4.Wiring method of solar inverter.....	15
5.Inverter daily ON or OFF operations.....	16

### BMS and communication functions

1.Lithium battery pack.....	17
1.1Introduction to communication interface.....	17
1.2DIP Switch Setting.....	18
1.3Communication.....	19
1.4Dry contact output description.....	20
1.5LED Indicator Description.....	20

### Technical specification

1.Solar inverter technical specification.....	22
2.Lithium battery pack technical specification.....	23

### Faults and solutions













1.Faults and solutionsCommon failure phenomenon.....	23
2.Code for alarm and Solution.....	23

### After-sales warranty regulations

1.Product Warranty.....	24
2.Warranty conditions.....	24
3.Warranty coverage.....	24

# Important Note

## 1.Instructions description

	Warning: you will be hurt if you don't follow the instruction
	Danger for high voltage and electrical shock.
	High temperature
	The parts can be recycled.
	This side up! Packaging must always be transported and stored in such a way that the arrow is always upward.
	The package stacked together should be no more than six (6) in same size.
	The product should not be handled as household waste
	Packaging/products should be handled carefully, it should not be tipped or tilted.
	Please use it with manual.
	Keep it dry! The packaging/product must be protected from moisture and must be stored under a cover.
	After turning off or completely disconnecting the machine for at least 10 minutes, you can touch or operate the inverter if an electric shock or injury occurs.
	CE Certificate

## 2.Before connection

- 1.Check the product and package after unpacking. If the product is damaged or some parts are missing, contact your local supplier
- 2.make sure the battery is off before installation
- 3.The battery must be well grounded and the resistance must be less than 100mΩ
- 4.Make sure the electrical parameters of the battery are compatible with related devices
- 5.Keep the battery away from water and fire

## 3.During usage

- 1.If the battery needs to be moved or repaired, the power must be cut and the battery must be completely turned off.
- 2.Non-isolated inverters: PV modules shall have Class A rated value as per IEC61730
- 3.Disassembling all-in-one ESS is prohibited.
- 4.Only dry powder fire extinguisher can be used in case of fire. Liquid fire extinguisher are strictly prohibited.
- 5.The neutral wire of off-grid side is not connected with the neutral wire of on-grid side of the inverter. Please follow the regulation by the local grid.

**Apart from our company or authorized personnel, no one is allowed to open, repair or disassemble the all-in-one ESS. We do not take any responsibility for any consequences or liability arising out of any breach in the contract.**



Li-ion



## 4.Important safety information



**A permit from a local utility company is required before connecting an inverter to the grid and hiring a employee.**

### **Before installation.:**

Check the installation location first to avoid product exposure to sunshine. Make sure the inverter and package is not damaged. If you have any doubt, contact the supplier before installing the inverter. Before connecting the PV panel, check the inverter voltage and ensure that it meets the ESS specifications.you should comply with all documentation attached to ESS. When the weight of ESS is more than 200kg, carry it with care.

### **Installation:**

All electrical installations must be carried out in accordance with local and national standard. Only trained, authorized personnel can install ESS. To ensure safety, please follow the steps in this manual.



**Before connecting the DC input and AC output, you must connect the ground cable. After installation, product identification must be clearly visible.**

### **ESS disconnection:**

Firstly disconnect the AC circuit, then disconnect the PV circuit, and finally disconnect the ground wire. Note that even if the ESS has been disconnected from the main power and the solar power, the voltage can still be very high and might be dangerous. Wait at least 20 minutes after disconnection and then you can operate.



### **Operation/ maintenance:**

Maintenance and installation of the equipment should be carried out by qualified personnel who have been trained with skills.

Before connecting the inverter to the power grid, make sure that the cabinet is closed. Do not open it when the system is running. There might be Risk of electric shock.

When the photovoltaic array is exposed to sunshine, it will provide DC voltage to the device

### **Safety parameters :**

Unauthorized modification of safety parameters may result in personal injury or inverter damage. In addition, this will disable the system operations . If non-original spare parts are used, the electrical safety, EMC safety and equipment safety will not be ensured.

## 5.Normal safety instructions



Electrical maintenance personnel should be responsible for life and property safety!

### **Isolation**

Disconnect all power cables before starting any work. Please note that NO voltage does not mean that the cable has been disconnected

### **Re-connection preventment**

Prevent system reconnecting by marking or closing/blocking the workspace. If it is reconnected, it can cause serious accidents

### **Check there is NO voltage in the ESS**

Use a voltage tester to make sure there is no voltage in the system. Check all terminals to ensure that there is no voltage on each conductor of the system

### **Cover live parts nearly and keep other parts away from the machine**

Cover all live components that may cause harm during operation. Make sure the danger areas are clearly marked.

# Introduce of energy storage ESS system

## 1. System introduction

ESS is an all-in-one energy storage system that integrates inverter and lithium battery into a cabinet, easier for installation. This system integrates the 3.2kW hybrid inverter with 3.072 kWh lithium battery and it becomes a perfect photovoltaic off-grid system.

## 2. System features

- ① The whole system is non-toxic, pollution-free and environmentally friendly
- ② The anode material is LiFePO<sub>4</sub>, which has good safety performance and long cycle life
- ③ Battery management system (BMS) has over discharge protection, over charge protection, over current protection, high/low temperature protections
- ④ The system can automatically manage charging and discharging states and balance the current and voltage of each battery
- ⑤ The system is pre-wired and has gone through factory test, so quick installation is available.
- ⑥ The operating temperature range is from -10°C to 50°C, discharge performance is excellent with long life span.
- ⑦ It is suitable for household appliances, communication base station equipment etc. And it's easy to install and operate the ESS.

## 3. Maintenance

- ① The system requires very little maintenance. The standard model only needs to be kept on charge frequently for life expectancy.
- ② If it is not used for a long time, it is recommended to charge it every three months.
- ③ Under normal circumstances, the lithium battery pack is designed to have a service life of 5 to 10 years. If it is found to be in poor condition, it must be replaced in advance. When replacing the battery, it must be performed by a professional.
- ④ Lithium battery packs should not be replaced individually. When replacing them as a whole, follow the instructions of our company's user manual.
- ⑤ Under normal conditions, the lithium battery pack should be charged and discharged once every three months, and then recharged after being discharged to shutdown, and the charging time of the standard model should not be less than 12 hours.
- ⑥ In high-temperature areas, the battery should be charged and discharged every two months, and the standard model should be charged for no less than 12 hours each time.

Note: Before replacing the lithium battery pack, turn off the inverter and unplug the mains input line and PV input line; do not wear metal objects such as rings and watches; use screwdrivers with insulated handles, and do not use tools or other metal. The item is placed on the battery.



**Warning: It is forbidden to short-circuit or reverse the positive and negative poles of the battery !**

# Interface introduction of energy storage ESS system

## 1.System Interface Introduction

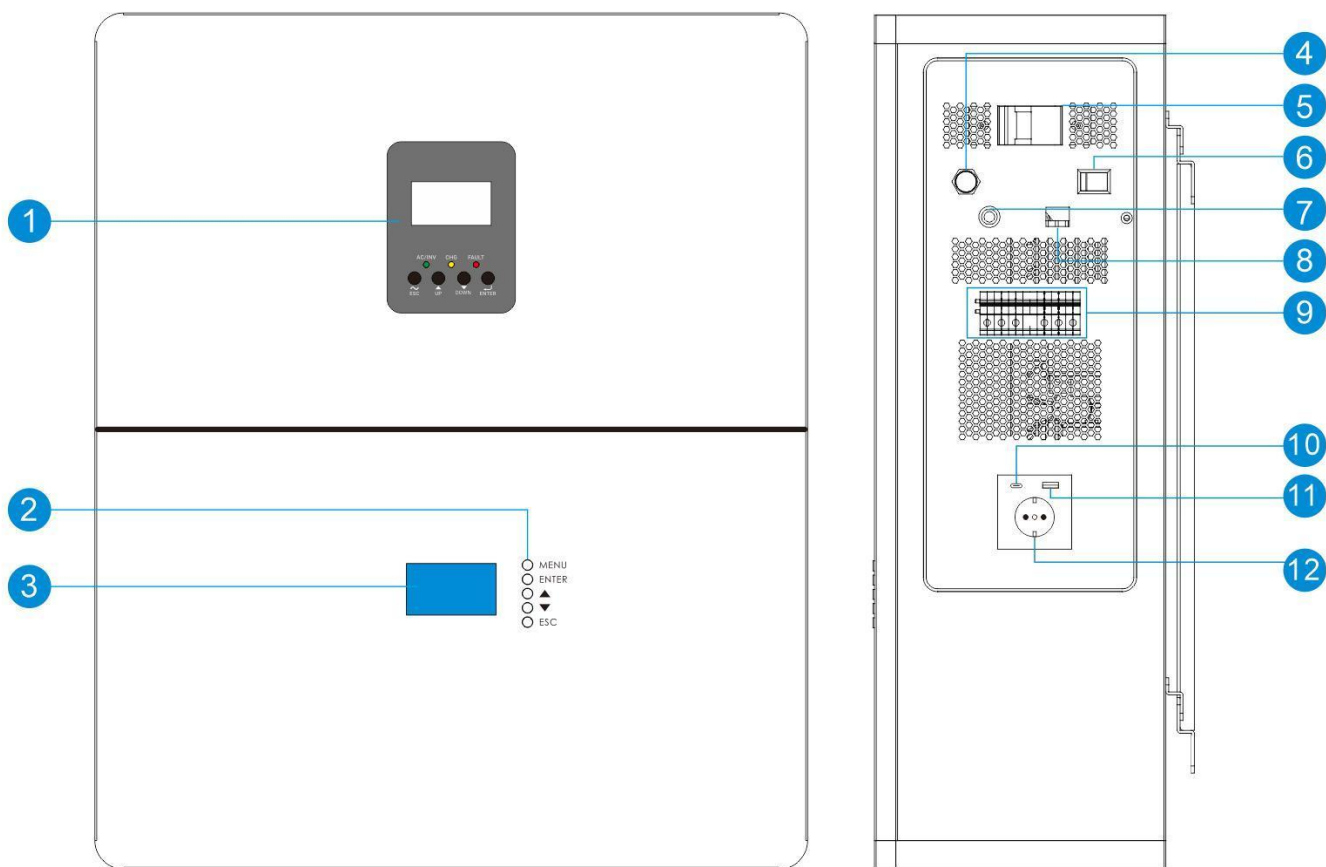

1	Inverter LCD Display
2	Lithium Battery LCD Display
3	Lithium Battery LCD Display Button
4	Lithium Battery Power Switch
5	Breaker
6	Inverter Power Switch
7	Inverter Fuse
8	RS232 Communication Port
9	Connecting terminal ①Solar input ②AC output ③ PE④ AC input
10	Type -C
11	USB
12	AC Socket

\*Note: The interface of customized series products may be different from the actual product , please refer to the actual product!

## 2.Display interface introduction

### Solar inverter

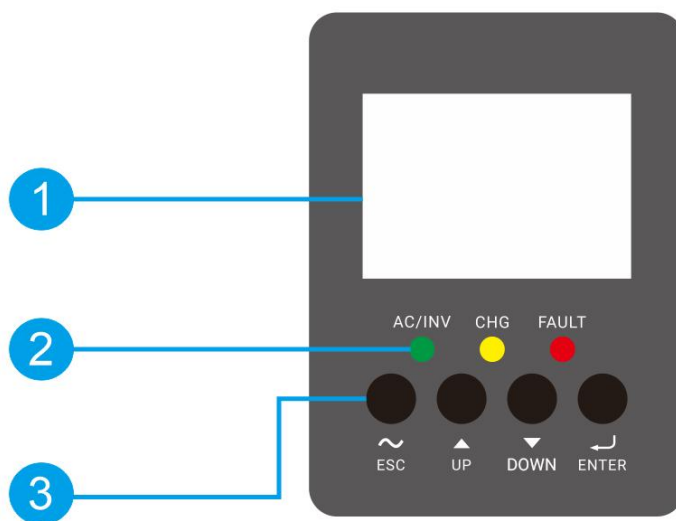

The three light-emitting diodes (LED) in the LED display area in the figure are used as indicators of operation status and fault.

NO.	Interface name	Information		
1	LCD	Display the working status of the energy storage system		
2	Indicator light	<b>AC/INV</b> Green light	Always on	In mains mode, the output is powered by mains
			Flashing	In lithium mode, the output is powered by battery/PV
		<b>CHG</b> Yellow light	Always on	Lithium battery fully charged
			Flashing	Lithium battery is charging
		<b>FAULT</b> Red light	Always on	Energy storage system is in failure mode
			Flashing	A warning state appears in the energy storage system
3	Action Key	~	ESC	When entering code or mode, it means exit, and when entering other interfaces, it means cancel.
		▲	UP	When querying mode, you can select other modes upwards
		▼	DOWN	When querying mode, you can scroll down to select other modes
		↵	ENTER	When entering code or mode, it is enter, and when entering other interfaces, it is page turning.

### 3. Inverter display function introduction

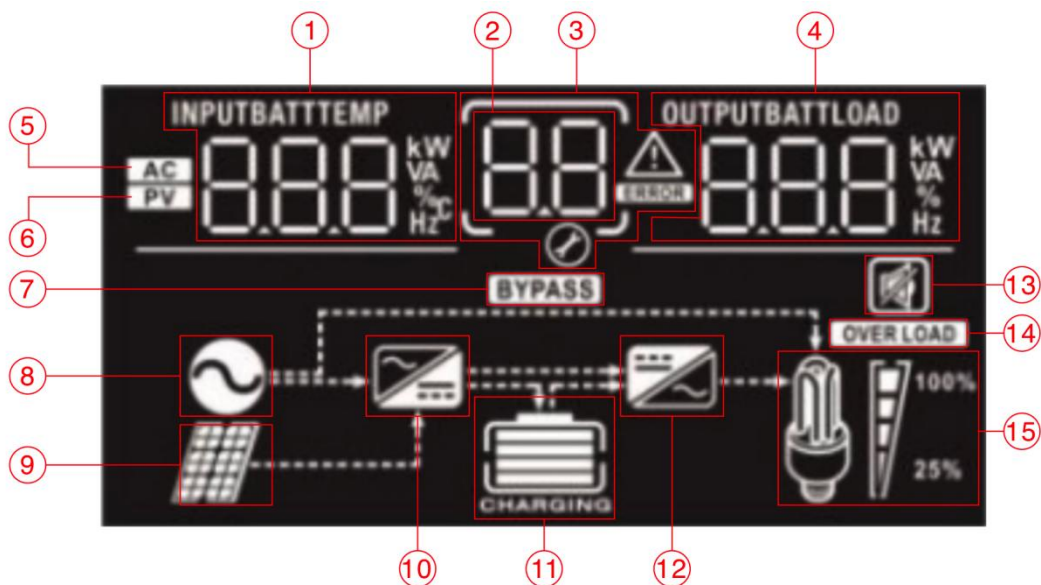

NO.	Interface name	Information
1	<b>INPUTBATT</b> 	Display input voltage, input frequency, photovoltaic voltage, charging current, charging power, battery voltage
2		Instructions for setting up procedures
3		Indicates alarm and fault codes. Warn:  Flashing warning code failure:  The light with the fault code comes on
4	<b>OUTPUTBATTLOAD</b> 	Displays output voltage, output frequency, battery percentage, power load and discharge current.
5		Indicates AC input
6		Indicates PV input
7		The load is powered by AC
8		Instructs the energy storage system to connect to AC/mains power
9		Instructs the energy storage system to connect to the PV
10		Indicates that the AC charging function is working
11		Displays 0-100% power ratio in lithium battery mode and charging status in AC mode
12		Indicates that the DC/AC inverter circuit is working
13		Silent Operation Indicates that system unit alarms are disabled
14		This system is overloaded

15		Indicates 0-100% power load ratio
----	---	-----------------------------------

**Lithium battery**

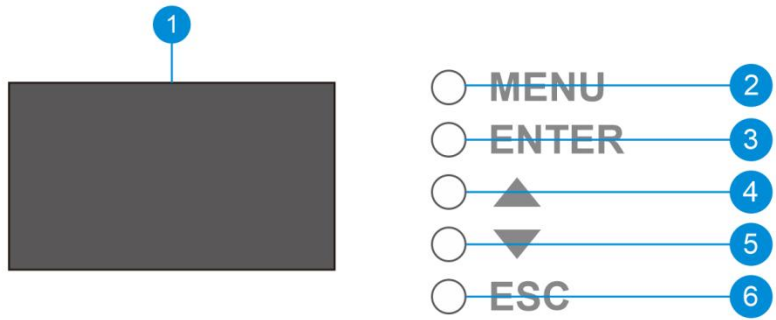

Lithium battery pack					
1	Display Area	3	Confirm button	5	Parameter Down /decrease Button
2	Menu Button	4	Parameter Up /increase Button	6	ESC Button

**1.Display function introduction**

①After the BMS is powered on/waked up, LCD model will be powered and went into main welcome interface as follows.

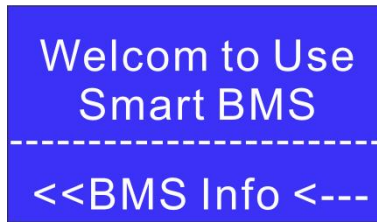

②While (MENU) button is pressed, the LCD will show the main information panel showing major battery status as follows:

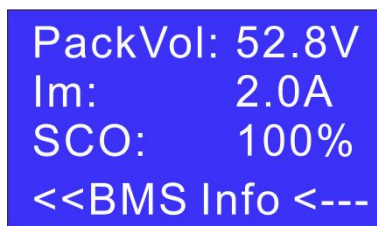

PackVol:Package voltage	Im:Package Current	SOC:SOC
-------------------------	--------------------	---------

③When Enter button is pressed, the LCD module will enter main setting interface. You can selected different items by pressing up/down buttons. Pressing the return button will make it go back to the main display interface.

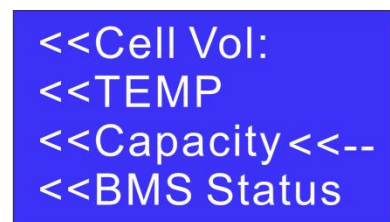
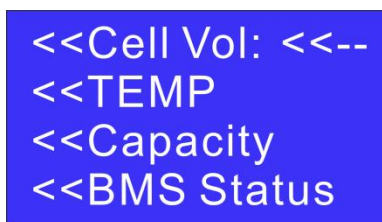

Cell Vol:Cell voltage	TEMP:Temperture
Capacity:Capacity	BMS Status:BMS state

④ Select the Cell Vol row in the main setting interface, pressing the Enter button, you will go to the battery cell voltage information interface. pressing up/down button, you can get the voltage information of the cells 1~16, pressing return button will go back to the previous directory.

--V1: 3300mV	--V5: 3302mV	--V9: 3301mV	--V13: 3301mV
--V2: 3298mV	--V6: 3301mV	--V10: 3300mV	--V14: 3299mV
--V3: 3301mV	--V7: 3303mV	--V11: 3302mV	--V15: 3302mV
--V4: 3302mV	--V9: 3301mV	--V12: 3301mV	--V16: 3298mV

⑤ Select the TEMP row in the main setting interface, pressing the Enter button, you will go to the temperature information interface. pressing up/down button, you can get the 6 way of T1~T4/environment/MOSFET temperature information, pressing return button will go back to the previous directory.

--T1: 22 °C	--ENV-T: 23 °C
--T2: 22 °C	--FET-T: 23 °C
--T3: 22 °C	
--T4: 22 °C	

ENV-T:Environment temperture	FET-T:MOSFET temperture
------------------------------	-------------------------

⑥ Select the Capacity row in the main setting interface, pressing the Enter button, you will go to the battery information interface. pressing return button will go back to the previous directory.

SOC: 100 %
SOH: 100 %
RM: 100.00Ah
CC: 11

SOC:The remaining capacity of the battery pack	RM:Remaining capacity of the battery pack
SOH:State of health of the battery pack	CC:Number of cycles

⑦ Select the BMS State row in the main setting interface, pressing the Enter button, you will go to the BMS Status information interface. pressing return button will go back to the previous directory.

State:Norm
<<BMS Status

State:Norm:BMS state
----------------------

# BMS and communication functions

## 1.Lithium battery pack

### 1.1 Introduction to communication interface

①RS232 communication port definition:

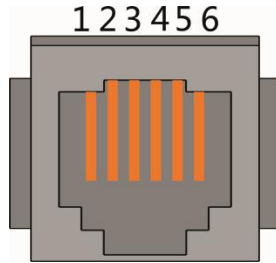

X7(RJ12)port

Interface	Definition description	
X7 Communication port definition	PIN 1	NC (void)
	PIN 2	NC (void)
	PIN 3	TX The protection board sends data (the data pin for host computer)
	PIN 4	RX The protection board receives data (host computer sends data)
	PIN 5	Ground Signal Ground
	PIN 6	NC (void)

②RS485-1/CAN communication port definition:

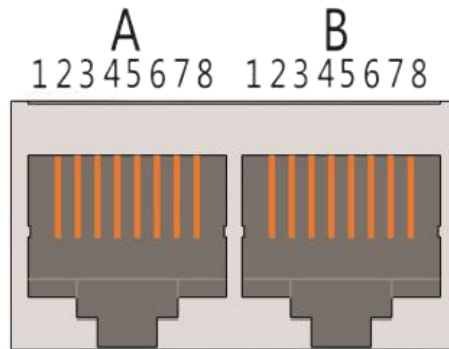

X1(dual RJ45)port

Interface	Definition Description			Definition Description		
	Part A CAN Port	PIN 1	CANL	Part B RS-485-1 Port	PIN 1	RS485-B1
PIN 2		CGND	PIN 2		RS485-A1	
PIN 3		NC (void)	PIN 3		RS485-GND	
PIN 4		CANH	PIN 4		RS485-B1	
PIN 5		CANL	PIN 5		RS485-A1	
PIN 6		NC (void)	PIN 6		RS485-GND	
PIN 7		CGND	PIN 7		NC (void)	

		PIN 8	CANH		PIN 8	NC (void)
--	--	-------	------	--	-------	-----------

③RS485-2 communication port definition:

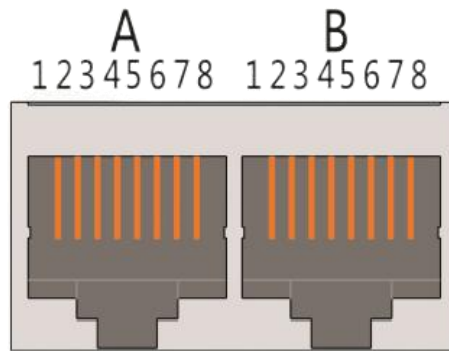

X2(dual RJ45)port

Interface	Definition Description				Definition Description			
X2 Communication port definition	Part A RS-485-2 Port	PIN 1	RS485-B2	Part B RS-485-2 Port	PIN 1	RS485-B2		
		PIN 2	RS485-A2		PIN 2	RS485-A2		
		PIN 3	RS485-GND		PIN 3	RS485-GND		
		PIN 4	NC (void)		PIN 4	NC (void)		
		PIN 5	NC (void)		PIN 5	NC (void)		
		PIN 6	RS485-GND		PIN 6	RS485-GND		
		PIN 7	RS485-A2	PIN 7	RS485-A2			
		PIN 8	RS485-B2	PIN 8	RS485-B2			

1.2 DIP Switch Setting:

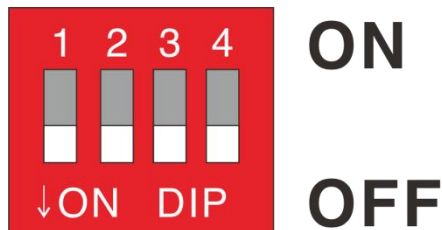

DIP Switch Diagram (SW1 Interface)

The coding switch is used to set the address of each BMS protection board, the value is 1 at position ON, 0 at position 1234, the master board address is 0, slave board address is 1~15.

DIP address table as following:

Position				ADD	Position				ADD	Position				ADD	Position				ADD
1	2	3	4		1	2	3	4		1	2	3	4		1	2	3	4	
0	0	0	0	1	0	0	1	0	5	0	0	0	1	9	0	0	1	1	13
1	0	0	0	2	1	0	1	0	6	1	0	0	1	10	1	0	1	1	14
0	1	0	0	3	0	1	1	0	7	0	1	0	1	11	0	1	1	1	15
1	1	0	0	4	1	1	1	0	8	1	1	0	1	12	1	1	1	1	16

### 1.3 Communication

#### RS232 Data Upload & Parameter Settings

BMS provides RS232 communication function to upload data for battery pack and parameters can be customized, the default baud rate is 9600bps, and the RS232 communication interface is RJ12 network port.

It can communicate with host computer through the RS232 port, can monitor the status and information of the battery pack in real time, and can re-modify and set the parameters of the protection board.

#### CAN communication Software Upgrade and Communication Function of inverter

The BMS provides mutual communication for the battery pack and the inverter to exchange data via CAN communication, the default baud rate is 500Kbps, and the CAN communication interface is the RJ45 network port. The BMS has the CAN communication function for software upgrade. The default baud rate is 500Kbps. The BMS can be updated and upgraded through host computer software.

#### RS485-1 communication and communication function of inverter or EMS

The BMS provides mutual communication for the battery pack and the inverter to exchange data via CAN communication, The default baud rate is 9600bps, and the RS485-1 communication interface is the RJ45 network port.

BMS provides RS485 communication function with network management system (EMS), the default baud rate is 9600bps

#### RS485-2 Data upload and cascading function

BMS provides RS485 communication function for uploading data of battery packs, it also provides RS485 uplink and cascade communication function. The default baud rate is 9600bps, and the RS485-2 communication interface is dual RJ45 network ports. Through the RS485-2 port, BMS can communicate with host computer, the status and information of the battery pack can be read and monitored in real time. (Parameters cannot be modified in RS485 communication)

#### Parallel (cascading) function of battery packs

When the battery packs are cascaded, the one with the communication address 0001 is called the master battery pack, and the rest with other communication address are called the slave battery packs. The slave battery pack can communicate with the master battery pack through the RS485 communication interface, and the master battery pack centrally packs and manages the data for each battery pack in the cascaded system.

When the battery packs are cascaded, only the master battery pack can communicate with the host computer, uploading the data, status and other information of all battery packs in the cascaded system, achieving remote monitoring by combing monitoring and management.

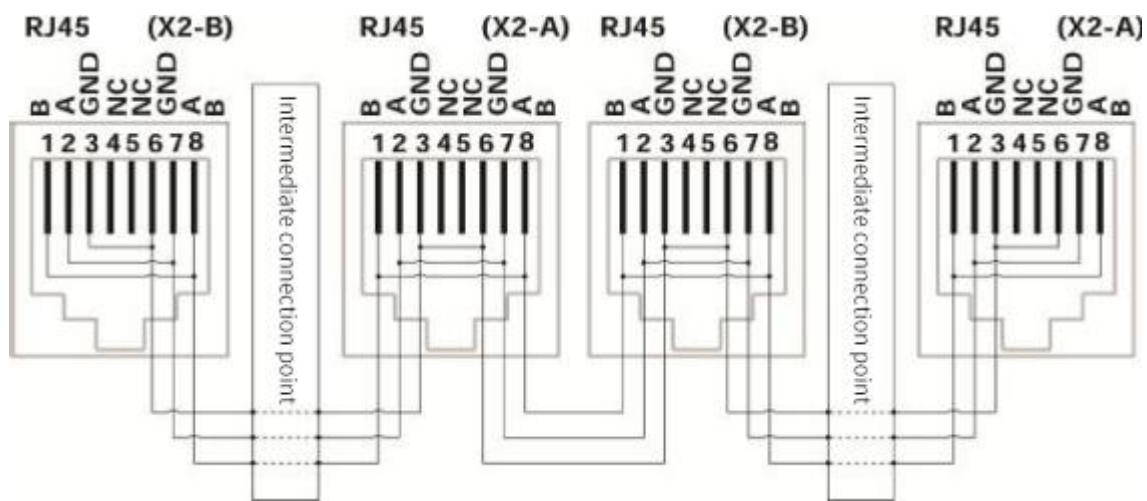

RS485 Parallel wiring diagram

When performing multi-machine parallel communication operation, it is necessary to configure the DIP address of each PACK first. The DIP code is in BCD format.



Address 1 is defined as ( black dot for OFF status, while for ON status, same as below ) ,



Address 2 is defined as ,



Address 3 is defined as , this applies to other addresses.

#### 1.4 Dry contact output description:

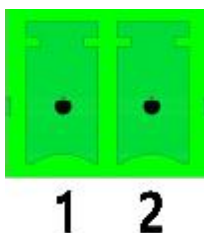

KRY1 (2EDG-3.81-2P) Interface

The ESS system can provide one channel of dry contact signal, all dry contact signals are passive switches, regardless of polarity

KRY1 (2P Terminals)		
BMS Status	Operation	Note
BMS Normal	1/2 pin is disconnected	SOC alarm, under-voltage and over-voltage alarm and output when BMS in protection state, such as under-voltage protection, over-voltage protection or short-circuit protection;
BMS at Protection	1/2 pin is connected	

#### 1.5 LED Indicator Description

##### ① LED Working Status

Status	Normal/Alarm, Protect	Running light	Alarm Light	Battery Capacity Indicator				Description
		Green	Red	Green L4	Green L3	Green L2	Green L1	
OFF	Sleep	OFF	OFF	OFF	OFF	OFF	OFF	All OFF
Standby	Normal	Flash1	OFF	Display according to battery capacity, Read the following table for battery capacity indications				Standby
	Alarm	Flash1	Flash3	Read the following table for battery capacity indications				Low battery
Charging	Normal	Always ON	OFF	Read the following table for battery capacity indications				Alarm when over-voltage, Light off
	Alarm	Always ON	Flash3	Read the following table for battery capacity indications				
	Over charge Protection	Always ON	OFF	ON	ON	ON	ON	If the charger is not connected, the indicator light is the same as the power standby state
Dis charging	Temperature, Over-current Protection	OFF	Always ON	OFF	OFF	OFF	OFF	Turn off charging
	Normal	Flash3	OFF	Read the following table for battery capacity indications				Turn off discharge
	Alarm	Flash3	Flash3	Read the following table for battery capacity indications				
	Over-discharge protection	OFF	OFF	OFF	OFF	OFF	OFF	Turn off discharge

	temperature, overcurrent short circuit protection	OFF	ON	OFF	OFF	OFF	OFF	Turn off discharge
Invalid		OFF	ON	OFF	OFF	OFF	OFF	Turn off charge and discharge

②LED Flash Description:

Flashing Type	ON	OFF
Flash1	0.25S	3.75S
Flash2	0.5S	0.5S
Flash3	0.5S	1.5S

③Battery Capacity Description:

Status		Charging				Discharging			
Battery Indicator		L4	L3	L2	L1	L4	L3	L2	L1
Capacity (%)	1~25%	OFF	OFF	OFF	閃 2	OFF	OFF	Off	ON
	25~50%	OFF	OFF	Flash 2	ON	OFF	OFF	ON	ON
	50~75%	OFF	Flash2	ON	ON	OFF	ON	ON	ON
	75~100%	Flash2	ON	ON	ON	ON	ON	ON	ON

④ON-OFF Switch Indicator Light:

<b>ON</b>	The LED indicators light up from the lowest capacity indicator (VL1) and light up in sequence in every 0.5s, all light up till the end of pre-charging
<b>OFF</b>	the LED indicators light up at the same time, after 1.5s, then starting from the lowest capacity indicator (VL1), all light up in sequence in every 0.5s

## Starting up and shutting down the energy storage system

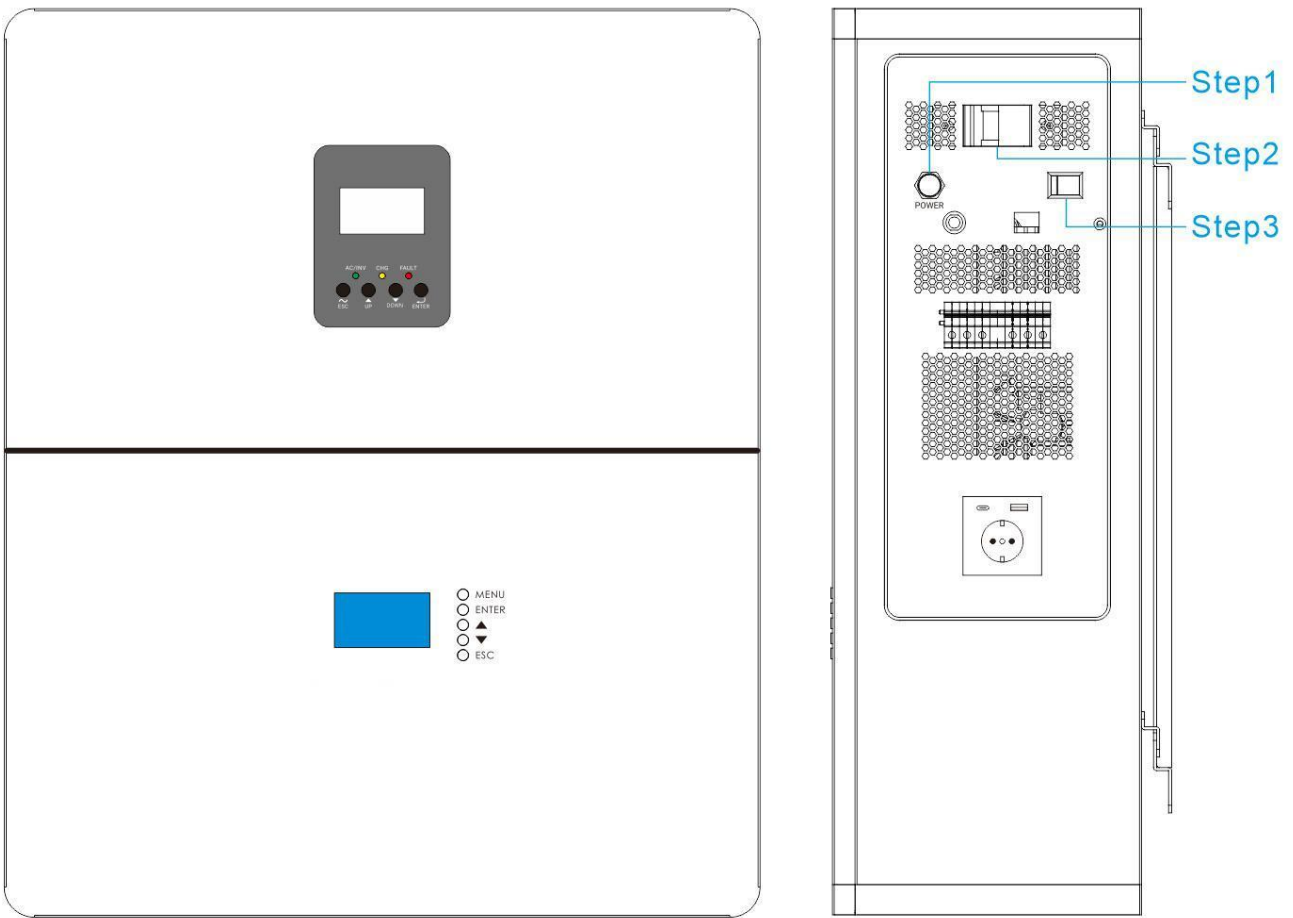

### Start steps







1. Ensure correct installation by pressing the battery power switch button
2. Turn on the circuit breaker switch
3. Turn on the inverter switch, and the system will automatically turn on. After waiting for a period of time, the panel will light up and the display screen will also light up. When you hear the buzzer, the system will be ready to run.

### Close steps

1. Turn off the inverter switch and turn off the circuit breaker switch
2. Turn off the battery switch

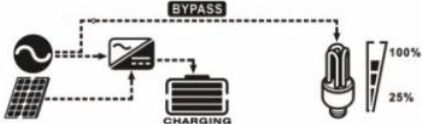
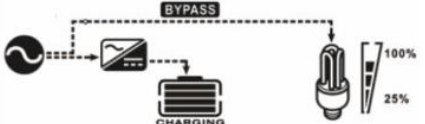
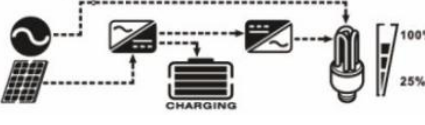
### Introduction to working mode

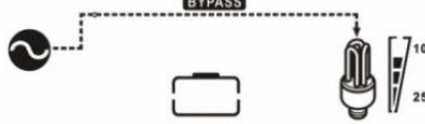
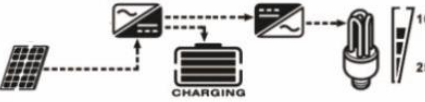
Operating mode	Run description	LCD display reference
<p><b>Standby work</b></p> <p>Note: The system has not been started yet and the battery can be charged by mains power without AC output.</p>	<p>In standby mode, the system does not provide power output, but the belt can still charge the lithium battery.</p>	<p>Mains power or PV can charge battery</p>
		<p>Mains power charging</p>
		<p>PV power charging</p>

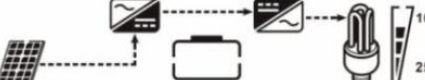
		 <p>Not charged</p> 
<p><b>Bypass mode</b></p>	<p>In this mode, output power will be provided from the mains. The system also charges the battery in this mode.</p>	<p>Mains and PV power charging</p> 
		<p>Mains power charging</p> 
		<p>If "PV priority" is selected first, and PV is not powerful enough to supply the load, PV and mains power will simultaneously supply the load and charge the battery.</p> 
		<p>If "PV Priority" is selected as the output source priority and no battery is connected, PV and mains supply power to the load.</p> 
		<p>Separate mains power supply</p> 
		<p><b>Battery mode</b></p>
<p>PV will power the load while charging the battery</p> 		
<p>Powered by battery only</p> 		
<p>Battery and PV output simultaneously to power the load</p> 		

## System working mode settings









After pressing the "ENTER" button for 3 seconds, the device will enter setup mode. Press the "Up" or "Down" button to select the setup program. Then, press "ENTER" to confirm your selection or press "ESC" to exit

### Setup procedure:

Procedure	Description	Optional options	
00	Exit setup mode	Exit 00 ESC	
01	Output source priority: Configure load power priority	AC priority (default) 01 USB	AC power will be given priority to the load. PV and batteries can only power the load when utility power is unavailable.
		PV first 01 SUB	PV provides priority to the load. If there is insufficient solar power to power all connected loads, AC will power the loads simultaneously.
		BU priority 01 SUBU	PV gives priority to providing power to the load. If the PV is insufficient to power all connected loads, battery energy will power the loads simultaneously. AC power will be supplied to the load only when the battery voltage drops to the low level warning voltage or the set point in Program 12.
02	Maximum charging current: configure the total charging current of PV and AC charger. (Maximum charging current = mains charging current + solar charging current)	60A (default) 02 60A	Settings range from 10A to 80A. The current increment per click is 10A.
03	AC input voltage range	APL (default) 03 APL	If selected, the acceptable AC input voltage range is between 90-280VAC.
		UPS 03 UPS	If selected, the acceptable AC input voltage range is between 170-280VAC.
05	Battery Type	AGN (default) 05 AGN	Gel battery 05 FLd
		Customize 05 USE	If Custom is selected, the battery charging voltage and low DC cutoff voltage can be set in Programs 26, 27 and 29.
		Available options in 5KW model: Battery fully charged 13 BATT FUL	54V (default) 13 BATT 54.0V
Settings range from 48V to 58V. The increment is 1V per click.			

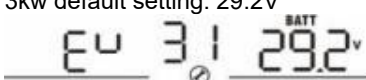
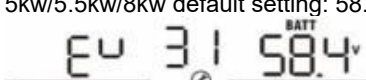
06	Automatic restart in case of overload	Restart disabled (default) 06 LFD	Reboot enabled 06 LFE
07	Automatically restart when the temperature is too high	Restart disabled (default) 07 LFD	Reboot enabled 07 LFE
08	ECO function: When the load is low in battery mode, the system will temporarily stop.	Disabled (default) ECO 08 SdS	Enable ECO 08 SEN
09	Output frequency	50Hz (default) 09 50.0	60Hz 09 60.0
10	Output voltage	220V 10 220V	230V(default) 10 230V
		240V 10 240V	
11	Maximum AC current Note: If the set value in program 02 is less than the set value in program 1 1, the inverter will use the charging current in program 02 to charge the AC charger	30A(default) 11 30A	The setting range is 2A, then from 10A to 60A. Each click increments by 10A.
12	Select in program 01 In "SBU Priority", the voltage point at which the power supply is converted from the battery back to AC.	Available options in 3kW model:	
		23V(default) 12 230 <sup>BATT</sup> V	Setting range is from 22V to 25.5V. Each click increments 0.5V
13	Select in program 01 In "SBU priority", the power supply is converted from AC back to the voltage point of the battery.	Available options in 5kW/5.5kW/8kW model:	
		46V(default) 12 46 <sup>BATT</sup> V	Setting range is from 44V to 51V. Each click increments by 1V.
13		Available options in 3kW model:	
		Battery fully charged 13 <sup>BATT</sup> FUL	27V (default) 13 27.0 <sup>BATT</sup> V
		Setting range is from 24V to 29V. Each click increments by 0.5V.	
		Available options in 5kW/5.5kW/8kW model:	
16	Charger priority: Configure charger priority	Battery fully charged 13 <sup>BATT</sup> FUL	54V (default) 13 54.0 <sup>BATT</sup> V
		Settings range from 48V to 58V. Each click increments by 1V.	
		If the inverter/charger is operating in online, standby or fault mode, the charger power supply can be programmed as follows:	
		AC priority 16 CUE	AC will give priority to charging the battery. PV will charge the battery only when the mains power is unavailable.
		PV priority 16 CSO	PV will give priority to charging the battery. Only when PV is unavailable will AC power charge the battery.

		PV and AC (default) 16 5NU	PV and mains power will charge the battery at the same time.
		Only PV 16 050	Whether there is AC or not, PV will be the only source of chargers.
		If the inverter/charger is working in battery mode, only the PV can charge the battery. If there is sufficient PV, the PV will charge the battery.	
18	Alarm control	Alerts on (default) 18 60N	Alarm off 18 60F
19	Automatically return to default display	Return to default display (default) 19 ESP	If checked, regardless of how the user switches the display, the display will automatically return to the default display (input voltage/output voltage) after 1 minute of no button pressing.
		Stay on latest screen 19 FEP	If checked, the display will stay on the last screen the user last switched to.
20	Backlight control	Backlight on (default) 20 LON	Backlight off 20 LOF
22	Beep when main source is interrupted	Alerts on (default) 22 AON	Alarm off 22 AOF
23	Overload bypass: When enabled, the device will transition to bypass mode if an overload occurs while in battery mode.	Bypass disabled (default) 23 bYd	Bypass enabled 23 bYE
25		Logging enabled (default) 25 FEN	Logging disabled 25 FdS
26	High charging voltage (CV voltage)	3kw default setting: 28.2V CU 26 28.2 <sup>BATT</sup>	
		5kw/5.5kw/8kw default setting: 56.4V CU 26 56.4 <sup>BATT</sup>	
		If you selected Customize in Program 5, you can set up the program. The setting range is 25V to 31.5V for the 3kW model and 48V to 61V for the 5kW model. The increment of each click is 0.1V.	
27	Float charge voltage	3kw default setting: 27V FLU 27 27.0 <sup>BATT</sup>	
		5kw/5.5kw/8kw default setting: 56.4V FLU 27 56.4 <sup>BATT</sup>	
28	Factory reset	Default Std 28 OFF Std 28 ON	
29	Low electrical cutoff voltage: If battery power is the only power source available, the converter will shut down.	If you selected Customize in Program 5, you can set up the program. The setting range for 3kW is 21V to 24V, and the setting range for 5/5.5/8kW is 42V to 48V. Each click increments by 0.1V. 3kW:	

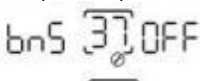
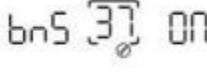
	If PV energy and battery power are available, the inverter will charge the batteries in the absence of AC output.	 5/5.5/8kW: 	
30	Cell balancing	Cell balancing 	Cell balancing disabled (default) 
		Can be set if "Gel Battery" or "Custom" is selected in Program 05.	
31	Battery balancing voltage	3kw default setting: 29.2V  5kw/5.5kw/8kw default setting: 58.4V 	
		The setting range for 3kW mode is 25V to 3.15V, and the setting range for 5kW/5.5kw/8kw mode is 48V to 61V. Each click increments by 0.1V.	
33	Battery balancing time	60 minutes (default) 	
		Settings range from 5 minutes to 900 minutes. Each click is in increments of 5 minutes.	
34	Battery balancing timeout	120 minutes (default) 	
		Settings range from 5 minutes to 900 minutes. Each click is in increments of 5 minutes.	
35	Equalization interval	30 days (default) 	
		The setting range is from 0 to 90 days. Each click is in increments of 1 day.	
36	Balance starts immediately	This program can be set if the equalization function is enabled in Program 30. If "Enable" is selected in this program, battery balancing will be activated immediately, and the LCD main page will display "E9 "; if "Disable" is selected, the balancing function will be canceled until the next activated balancing time is reached according to the settings of Program 35 . At this time, "E9 " will not be displayed on the LCD main page.	
37	BMS function switch	Off (default)  	
		Whether to enable BMS communication function	

## Technical parameters

### 1. Solar inverter technical specification

Model		3200W
Input	Input source	L+N+PE
	Rated input voltage	220/230/240VAC
	Voltage range	154-264VAC±3V ( APL model ) 185-264VAC±3V ( UPS model )
	Frequency	50Hz/60Hz ( Automatic Identification )
Output	Rated power	3200W
	Output voltage	220/230/240VAC±5%
	Output frequency	50/60Hz±0.1%
	Waveform	Pure sine wave

	Switching time(adjustable)	Computer(UPS model) 10ms , home equipment(APL model )20ms
	Peak power	6.4kW(1~3ms)
	Overload capacity	Battery mode: 2 1s@ 105%~ 150% load 1 1s@ 150%~ 200% load 400ms@>200% load
	Peak efficiency (battery mode)	>94%
Battery	Battery voltage	24Vdc
	Constant charging voltage (adjustable)	25.6Vdc
	Floating charging voltage (adjustable)	25.6Vdc
PV&Mains power	PV charging mode	MPPT
	Maximum PV input power	3200W
	MPPT tracking range	120~ 500Vdc
	Best voltage	300~400V
	Maximum PV input voltage	500Vdc
	PV charging current maximum value	60A
	Maximum AC charging current	60A
	Maximum charging current	100A
Environment	Operating temperature	0~40℃
	Humidity	20%~95% ( non-condensing )
	Storage temperature	-15~60℃
	Altitude	The altitude does not exceed 1,000m. If it exceeds 1,000m, it will be derated. The maximum altitude is 4,000m.
	Noise	≤50dB
Display		Display operating mode/load/input/output information parameters, etc.
Communication		RS232 Baud rate 2400,Lithium battery BMS, WiFi, dry contact

## 2.Lithium battery pack technical specification

Model:	
Storage capacity	25.6V120Ah/3.072kWh
Cell type	Lithium iron phosphate
Standard discharge current	50A
Maximum discharge current	100A
Working voltage range	20~29.2VDC
Standard Voltage	25.6VDC
Maximum charging current	100A
Maximum charging voltage	29.2V
Suggested DOD model	DOD 80%
IP Rating	IP20
Communication	RS485/RS232/CAN

















Cooling method	Natural cooling
Fire-fighting measures	Aerosol 25g
Working temperature	0~40℃
Storage environment temperature	-10~60℃
Working humidity	65±20%RH

## Function and alert description

### 1. Fault description











Fault: The inverter enters fault mode, the red LED light is always on, and the LCD displays the fault code.

Fault reference code

Error cod	Failure event	Icon display
01	When the inverter is switched off, the fan is locked.	
02	The temperature is too high or the NTC connection is poor.	
03	Battery voltage is too high.	
04	Battery voltage is too low.	
05	Output short circuit or overheating is detected inside the machine	
06	The output voltage is too high.	
07	Overload timeout.	
08	The bus voltage is too high.	
09	Bus soft start failed.	
51	Over current or surge.	
52	Bus voltage is too low.	
53	The inverter soft start failed.	
55	The DC voltage in the AC output is too high.	
57	Current sensor failure.	
58	The output voltage is too low.	
59	PV voltage exceeds the limit.	

### 2. Warning description

Alarm: The red LED flashes, the LCD displays the alarm code, and the inverter does not enter fault mode.

Warning code	Warning event	Audible alarm	Icon display
01	When the inverter is turned on, the fan is locked.	Three beeps every 1 second	
02	Temperature is too high	none	
03	Battery overcharged	Beep every 1 second	
04	low power	Beep every 1 second	
07	overload	Beep every 0.5 seconds	
10	Output power derating	Two beeps every 3 seconds	
15	PV energy is low.	Two beeps every 3 seconds	
16	High AC input (>280VAC) during bus soft-start	none	
E9	Cell balancing	none	
BP	Battery not connected	none	

### 3. Accident handling

Accident problem	Display/LED/Buzzer	Explanation/possible cause	Solution
The inverter switches off automatically during startup.	The display and buzzer will activate for 3 seconds and then turn off completely.	The battery voltage is too low <1.91V (single cell battery)	1. Charge the battery 2. Replace the battery
No response after power on.	No instructions	1. The battery voltage is too low <1.4V (single cell battery) 2. Internal fuse tripped	1. Contact the service center to replace the fuse. 2. Charge the battery. 3. Replace the battery. Check whether the AC circuit breaker is tripped and whether the AC wiring is well connected
There is AC input, but the device operates in battery mode.	The LCD screen shows that the input voltage is 0 and the green LED flashes.	Input protector tripped	1. Check whether the AC wire is too thin or too long. 2. Check whether the generator (if used) is working properly, or whether the input voltage range is set correctly. (up→device) First change the output source priority to AC priority
	The green LED flashes.	AC power quality is insufficient. (AC or generator is unstable)	
	The green LED flashes.	Set "PV Priority" to the priority of the output source.	
When the unit is turned on, an internal relay opens and closes repeatedly.	LCD screen and indicator lights flash	Battery disconnected.	Check if the battery wires are well connected
The buzzer keeps beeping and the red LED lights up.	Fault code 07	Overload protection. Inverter overload 105%	Reduce the load on the connection by turning off some devices.
		If the PV input voltage is higher than specified, the output power will be reduced. At this time, if the connected load is higher than the derated output power, it will cause overload.	Reduce the number of PV modules or connected loads in series.
	Fault code 05	Output short circuit	Check whether the wiring is well connected and remove abnormal loads.
		Internal converter component temperature exceeds 120°C	Check to see if airflow to the unit is blocked or the ambient temperature is too high.
	Fault code 02	The internal temperature of the inverter components exceeds 100°C	
	Fault code 03	The battery is overcharged.	Return to repair center.
		Battery voltage is too high.	Check whether the battery specifications and quantity meet the requirements.
	Fault code 01	Fan failure	Replace fan
	Fault code 06/58	Abnormal output (inverter voltage is lower than 190VAC or higher than 260VAC)	1. Reduce connection load. 2. Return to the repair center
	Fault code 08/09/53/57	Internal component failure	Return to repair center.
	Fault code 51	Overcurrent or surge	Restart the device and if the error occurs again, return to the service center.
Fault code 52	Bus voltage is too low.		
Fault code 55	The output voltage is unbalanced.		
Fault code 59	PV input voltage is out of specification	Reduce the number of PV modules in series.	

## Installation

1. Before the load is connected to the ESS system, please turn off all loads;
2. In order to ensure safety, please make sure that the product is properly grounded before using it.
3. When the gear load is an inductive load such as a motor/compressor/laser printer/special lighting negative, because the starting power of the operation is too large, when selecting the power of the inverter, the starting power of the load should be calculated. The starting power of the load is generally 2-3 times the rated power
4. The location of the ESS system (Refer to the figure)



★ Avoid direct sunlight

★ Avoid moisture and contact with liquids



★ Avoid dust

★ Avoid overheating



★ Ground level installation

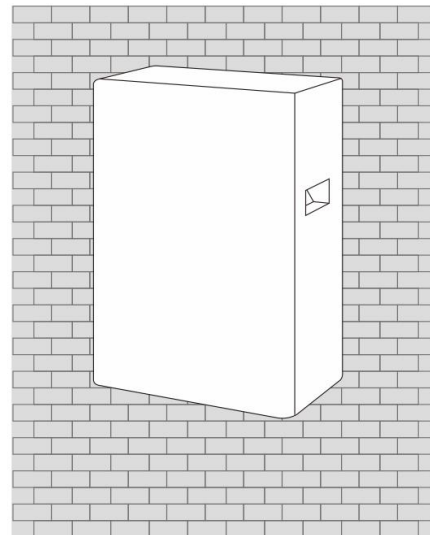
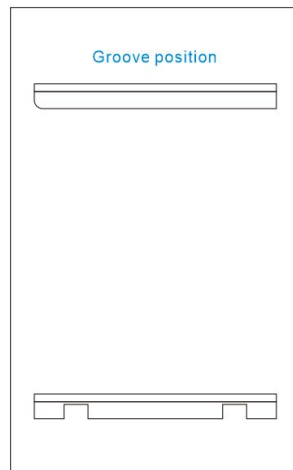
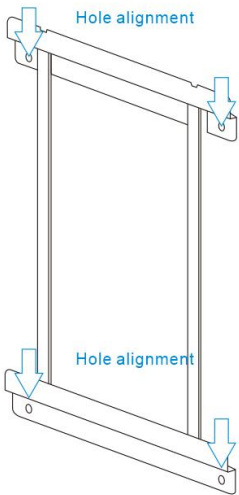

## AC input and output connections

**NOTE:** Please install a separate AC circuit breaker between the inverter and the AC input power before connecting to the AC input power. This will ensure that the inverter can be disconnected during maintenance and prevent excessive AC input current. The recommended circuit breaker specifications are 32A for 3KW and 50A for 5KW.

**NOTE:** There are two terminal strips marked "IN" and "OUT". Please do not connect the input and output connectors incorrectly.

**WARNING!** All wiring must be performed by qualified personnel.

**WARNING!** Using appropriate cables to connect the AC input is very important for safe and efficient operation of the system. To

reduce the risk of injury, use the appropriate cable sizes recommended below.

### Recommended Cable Requirements for AC Wires

Model	Wire gauge	Torque value
5kW/5kWh	8AWG	1.4~ 1.6Nm
6.2kW/10kWh	6AWG	1.6~ 1.8Nm

### PV connection

Note: Before connecting the PV module, please install a separate DC circuit breaker between the inverter and the PV module, 32A is recommended. WARNING! All wiring must be performed by qualified personnel.

WARNING! Using appropriate cables to connect PV modules is very important for safe and efficient operation of the system. To reduce the risk of injury, use the appropriate cable sizes recommended below.

Typical amperage	Wire gauge	Torque value
30A	12AWG	1.4~ 1.6Nm

### PV module selection

When choosing the right PV modules, make sure you consider the following requirements first:

The open circuit voltage (Voc) of the PV module does not exceed the maximum PV array open circuit voltage of the inverter. For best performance, the maximum supply voltage of the PV module should be close to the optimal PV access voltage range of the inverter. If one PV module cannot meet this requirement, multiple PV modules need to be connected in series.

### PV module wire connection

Please follow the steps below to implement PV module connections:

1. Remove 10 mm of the insulation sleeves of the positive and negative wires.
2. It is recommended to use a suitable crimping tool to secure the wire to the positive terminal and the end of the negative wire
3. As shown in the figure, secure the wire cover to the on the inverter.

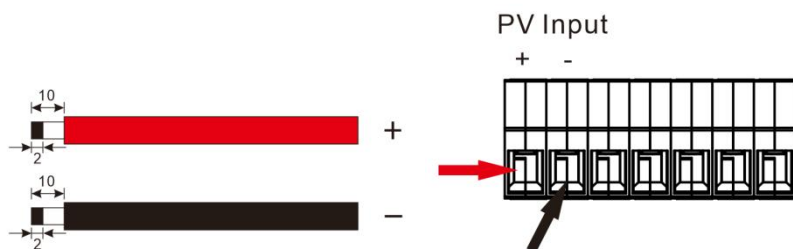

4. Check whether the wire polarity of the PV module and PV input connector is correct. Then connect the positive (+) side of the cable to the positive (+) side of the PV input connector. Connect the negative pole (-) of the connecting cable to the negative pole (-) of the PV input connector. Tighten both wires clockwise.

## After-sales warranty regulations

### 1. Product Warranty

The system is integrated with a photovoltaic inverter and an energy storage lithium battery, and the performance guarantee of the dedicated battery module is ten years from the date of product manufacture.

This warranty does not cover any accessories and tool kits provided with the product. This warranty only covers the repair or replacement of defective products. We will repair or replace the product (if the product is defective and returned within the warranty period). Repaired or replaced products will continue for the remainder of the original warranty period. In either case, it should not be used as a reason to renew the warranty period.

### 2. Warranty conditions

Warranties relating to products apply only in the following cases:

1. Purchased from our company or our authorized dealer.
2. Have an official serial number;
3. Install, operate and maintain according to the "Product Manual";
4. For daily use, use photovoltaic (PV) energy storage at 80% depth of discharge.

### 3. Warranty coverage

To the extent permitted by law, the company disclaims liability for any damage to or defect in the product caused by or contributed to by:

1. The product is installed with an inverter that has not been certified by our company;
2. Failure to install or operate the system/battery correctly according to the product manual;
3. Negligence or any other inappropriate treatment of the product, including using the product beyond the recommended environmental, temperature and humidity conditions;
4. Transportation, including but not limited to dropping, trampling, deforming, impacting or puncturing sharp objects;
5. The storage, installation, commissioning, modification or repair of the product performed by other personnel: other people than the company certified installer;
6. Abuse, misuse, negligence, accident or force majeure event, including but not limited to lightning, flood, fire, extreme cold weather or other events beyond the reasonable control of the Company;
7. Any attempt to extend or shorten the life of the product, whether by physical means, programming or otherwise, without the company's written confirmation;
8. Water, conductive dust or corrosive gas; normal wear and tear or deterioration, or surface defects, dents or marks will affect product performance
9. The product has been connected with different types of battery modules;
10. Failure to install, operate or maintain the product in accordance with the product manual; theft or vandalism of the product or any component thereof.